

MESSRS : _____

AGENT : _____

**SPECIFICATION
OF
THERMOPILE
INFARAED SENSOR**

MODEL NO. : TS-S2NMB-2R

PART NO. : _____

176-17 Hirooka, Tottori-shi, 689-1193 JAPAN
TEL : +81-857-53-4666 FAX : +81-857-53-3532

APPROVED BY	CHECKED BY	DRAWN BY

MODEL NO. : TS-S2NMB-2R	DRAWING NO. : 1707151	REV : A	PAGE 1 / 8	JULY ,17, 2015
PART NO. :				 NIPPON CERAMIC CO., LTD.

SCOPE

THIS SPECIFICATION DESCRIBES A THERMOPILE INFRARED SENSOR SUPPLIED BY NIPPON CERAMIC CO., LTD.

TYPE OF SENSOR

SINGLE ELEMENT TYPE.

PHYSICAL CONFIGURATION

- 1) PACKAGE : TO-18 METAL CAN WITH DIMENSIONS SHOWN IN FIGURE 1-C
- 2) ELEMENT GEOMETRY : SENSITIVE AREA 0.64 mm²
- 3) ELEMENT ORIENTATION : SEE FIGURE 1-B
- 4) LEAD CONFIGURATION : SEE FIGURE 1-C, 1-D

ELECTRICAL CHARACTERISTICS (AT 25±5 °C)

- 1) CIRCUIT CONFIGURATION : FOUR-TERMINAL SENSOR
SEE FIGURE 2
- 2) SIGNAL OUTPUT : 2.43mV_{0-p} ± 25%
(REFERENCE)
(CONDITIONS) ENERGY : 20.6 mW/cm² (323K AT SHUTTER OPENING)
AMP. GAIN : WITHOUT AMP.
TEST SET-UP BLOCK DAGRAM : REFER TO FIGURE 2
- 3) RESISTANCE OF THERMOPILE (Pin1~Pin3)
: 175kΩ ± 30kΩ (at 25°C)
- 4) REFERENCE RESISTOR (Pin2~Pin4)
: 100kΩ ± 5% (at 25°C)

OPTICAL CHARACTERISTICS

- 1) FIELD OF VIEW : 90° FROM CENTER OF SENSITIVE ELEMENT
: SEE FIGURE 1-A
- 2) FILTER SUBSTRATE : SILICON
- 3) CUT ON (5% TABS) : 5.0 ± 0.5 μm
- 4) TRANSMISSION : ≥70% AVERAGE 7.0~14 μm (SEE FIGURE 4)

MODEL NO. : TS-S2NMB-2R	DRAWING NO. :	REV :	PAGE	JULY ,17, 2015
PART NO. :	1707151	A	2 / 8	 NIPPON CERAMIC CO., LTD.

ENVIRONMENTAL REQUIREMENTS

- 1) OPERATING TEMPERATURE : -30°C TO +80°C
- 2) STORAGE TEMPERATURE : -30°C TO +100°C
- 3) RELATIVE HUMIDITY :

THE SENSOR SHALL OPERATE WITHOUT INCREASE IN NOISE OUTPUT WHEN EXPOSED TO 90 ~ 95 % RH AT 30 °C CONTINUOUSLY.

MODEL NO. : TS-S2NMB-2R	DRAWING NO. :	REV :	PAGE	JULY ,17, 2015
PART NO. :	1707151	A	3 / 8	 NIPPON CERAMIC CO., LTD.

CONFIGURATION (FIGURE 1)

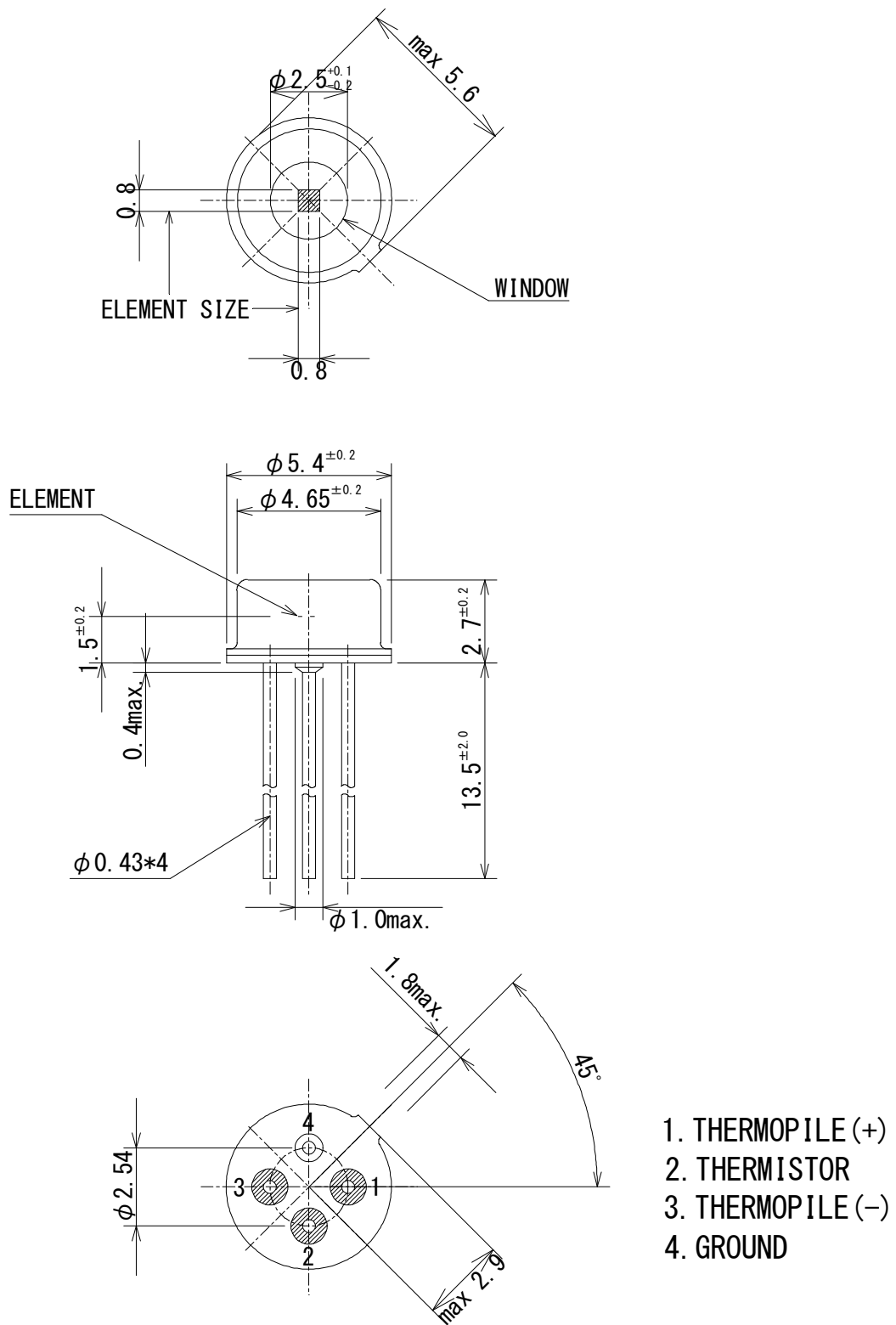

UNIT : mm

MODEL NO. : TS-S2NMB-2R	DRAWING NO. : 1707151	REV : A	PAGE 4 / 8	JULY ,17, 2015
PART NO. :				NIPPON CERAMIC CO., LTD.

CIRCUIT CONFIGURATION(FIGURE 2)

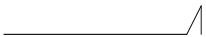

MODEL NO. : TS-S2NMB-2R	DRAWING NO. :	REV :	PAGE	JULY ,17, 2015
PART NO. :	1707151	A	5 / 8	 NIPPON CERAMIC CO., LTD.

TRANSMISSION (FIGURE 4)



MODEL NO. : TS-S2NMB-2R	DRAWING NO. : 1707151	REV : A	PAGE 6 / 8	JULY ,17, 2015
PART NO. :				 NIPPON CERAMIC CO., LTD.

※ NOTES

1. DESIGN RESTRICTIONS/PRECAUTIONS

IF USED FOR OUTDOOR APPLICATIONS, BE SURE TO APPLY SUITABLE SUPPLEMENTARY OPTICAL FILTER AND DRIP-PROOF, ANTI-DEW CONSTRUCTION. THIS SENSOR IS DESIGNED FOR INDOOR USE. IN CASES WHERE SECONDARY ACCIDENTS DUE TO OPERATION FAILURE OR MALFUNCTIONS CAN BE ANTICIPATED, ADD A FAIL SAFE FUNCTION TO THE DESIGN.

2. USAGE RESTRICTIONS/PRECAUTIONS

TO PREVENT SENSOR MALFUNCTIONS, OPERATIONAL FAILURE OR ANY DETERIORATION OF ITS CHARACTERISTICS, DO NOT USE THIS SENSOR IN THE FOLLOWING, OR SIMILAR, CONDITIONS.

- A. IN RAPID ENVIRONMENTAL TEMPERATURE CHANGES.
- B. IN STRONG SHOCK OR VIBRATION.
- C. IN A PLACE WHERE THERE ARE OBSTRUCTING MATERIALS (GLASS, FOG, ETC.) THROUGH WHICH INFRARED RAYS CANNOT PASS WITHIN DETECTION AREA.
- D. IN FLUID, CORROSIVE GASES AND SEA BREEZE.
- E. CONTINUAL USE IN HIGH HUMIDITY ATMOSPHERE.
- F. IN FIELD OF STATIC ELECTRICITY OR STRONG ELECTROMAGNETIC WAVES.
- G. EXPOSED TO DIRECT WIND FROM A HEATER OR AIR CONDITIONER.

3. ASSEMBLY RESTRICTIONS/PRECAUTIONS

SOLDERING -----

- A. USE SOLDERING IRONS WHEN SOLDERING.
- B. AVOID KEEPING PINS OF THIS SENSOR HOT FOR A LONG TIME AS EXCESSIVE HEAT MAY CAUSE DETERIORATION OF ITS QUALITY. (E. G. WITHIN 10 SEC. AT 260°C)

WASHING -----

- A. BE SURE TO WASH OUT ALL FLUX AFTER SOLDERING AS REMAINDER MAY CAUSE MALFUNCTIONS.
- B. USE A BRUSH WHEN WASHING. WASHING WITH AN ULTRASONIC CLEANER MAY CAUSE OPERATIONAL FAILURE.

4. HANDLING AND STORAGE RESTRICTIONS/PRECAUTIONS

TO PREVENT SENSOR MALFUNCTIONS, OPERATIONAL FAILURE, APPEARANCE DAMAGE OR ANY DETERIORATION OF ITS CHARACTERISTICS, DO NOT EXPOSE THIS SENSOR TO THE FOLLOWING OR SIMILAR, HANDLING AND STORAGE CONDITIONS.

- A. VIBRATION FOR A LONG TIME.
- B. STRONG SHOCK.
- C. STATIC ELECTRICITY OR STRONG ELECTROMAGNETIC WAVES.
- D. HIGH & LOW TEMPERATURE AND HUMIDITY FOR A LONG TIME.
- E. CORROSIVE GASES OR SEA BREEZE.
- F. DIRTY AND DUSTY ENVIRONMENTS THAT MAY CONTAMINATE THE OPTICAL WINDOW.

MODEL NO. : TS-S2NMB-2R	DRAWING NO. :	REV :	PAGE	JULY ,17, 2015
PART NO. :	1707151	A	7 / 8	 NIPPON CERAMIC CO., LTD.

5. RESTRICTIONS ON PRODUCT USE

THE PRODUCT DESCRIBED IN THIS DOCUMENT SHALL NOT BE USED OR EMBEDDED TO ANY DOWNSTREAM PRODUCTS OF WHICH MANUFACTURE. USE AND/OR SALES ARE PROHIBITED UNDER ANY APPLICABLE LAWS AND REGULATIONS.

SENSOR TROUBLES RESULTING FROM MISUSE, INAPPROPRIATE HANDLING OR STORAGE ARE NOT THE MANUFACTURER' S RESPONSIBILITY.

MODEL NO. : TS-S2NMB-2R	DRAWING NO. :	REV :	PAGE	JULY ,17, 2015
PART NO. :	1707151	A	8 / 8	 NIPPON CERAMIC CO., LTD.